

ROLLCONTAINER BESTELL-NR. 120010 STANDARD-AUSFÜHRUNG

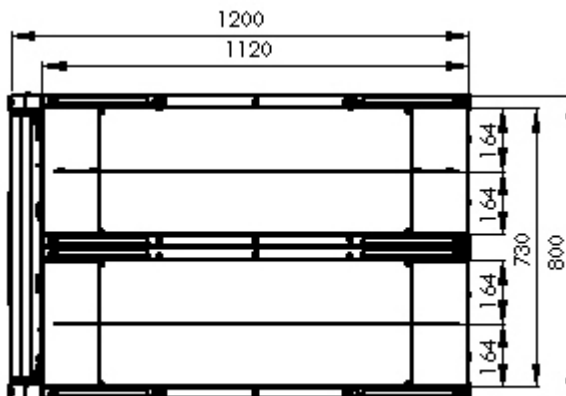

Schnitt Ebene 1

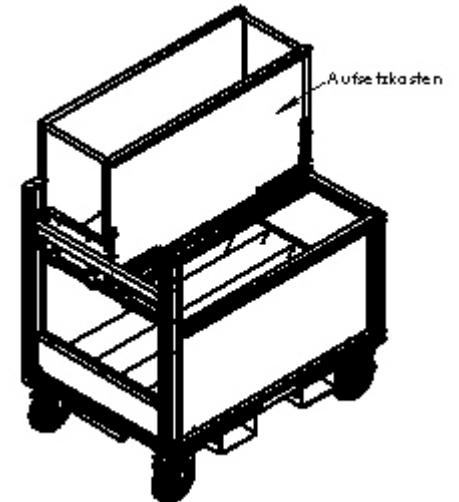
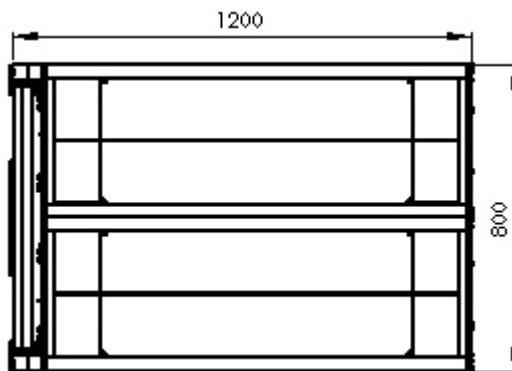
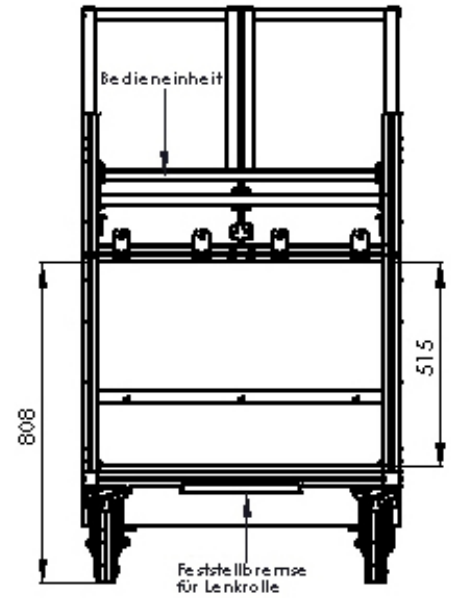
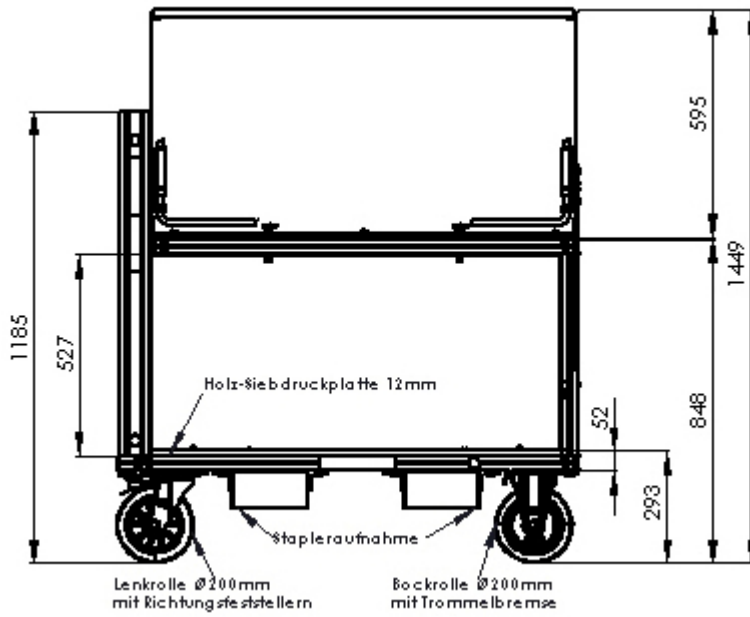
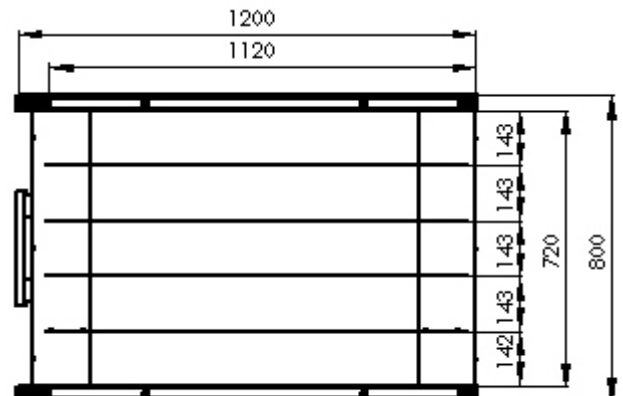

Schnitt Ebene 2

ROLLCONTAINER
 BESTELL-NR. 120010
SONDER-AUSFÜHRUNG



Technische Daten			
Breite	B	mm	
Länge	L	mm	
Höhe	H	mm	
Max. Höhe		mm	
Max. Gewicht		kg	

Zubehör	Stk.	ja	nein
Zwischenboden			
Stapleraufnahme			
Hebeöse			
Zugöse			

Rollen	ja	nein
Standard (2 Bock-, 2 Lenkrollen)		
Quadro (4 Lenkrollen)		

Beladungsgegenstände / Notizen

Kontaktdaten	
<input type="checkbox"/> Feuerwehr <input type="checkbox"/> Händler	
Ansprechpartner für Rückfragen	
Telefon	
E-Mail	