

Order no.: 800010

Spare parts for platform ladders and platform stairs

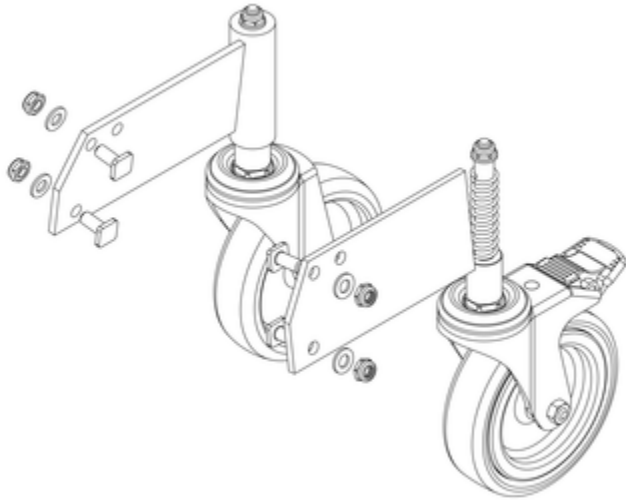

Specification

Weight 3.1 kg	Transport dimensions 400 x 400 x 200 mm, 3.1 kg	Business division MUNK Günzburger Steigtechnik	Order no. 800010	Price € 120.00
-------------------------	---	--	----------------------------	--------------------------

Facts

■

Information on sustainability criteria

- Corporate certification: ISO 9001
- Corporate certification: EN 1090
- Corporate certification: EcoVadis
- RoHS
- REACH
- The MUNK Group complies with a Code of Conduct
- The Supply Chain Act does not apply due to our size
- The materials used are listed in the technical specification
- Resource-saving production: own photovoltaic systems

- Energy-efficient consumption during production: LED lighting
- Repairability, durability and quality: 15-year warranty on series products made in Germany
- Recyclability: Our products are mostly made of aluminium, steel or wood and can be fed directly into the recycling process.
- Socially acceptable working conditions in production: fair wages, gender equality
- Economical and recyclable packaging: no use of polystyrene, predominantly use of wood and cardboard, small amounts of plastic
- No health hazards for the users

More product pictures

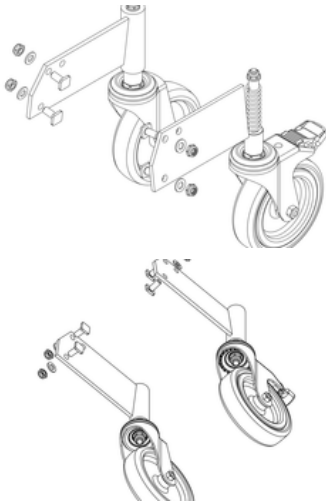

Corporate certifications

on sustainability criteria



Management System
ISO 9001:2015
ISO 14001:2015
www.tuv.com
ID 9108612548

